

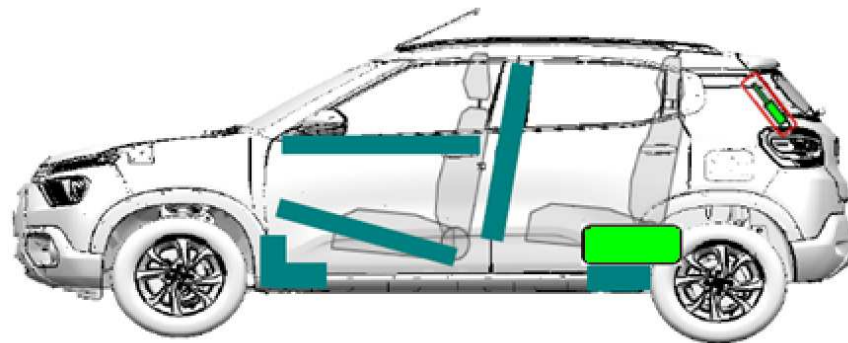

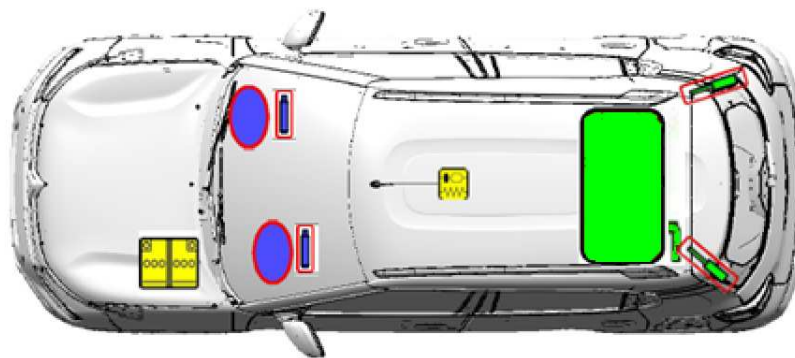

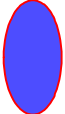























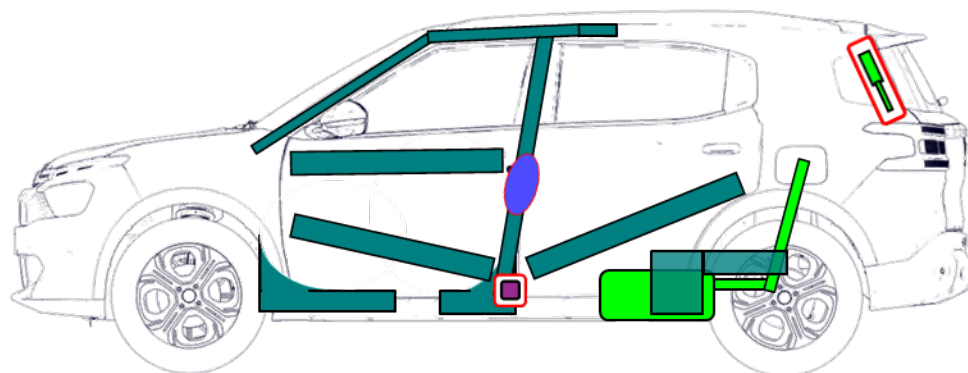
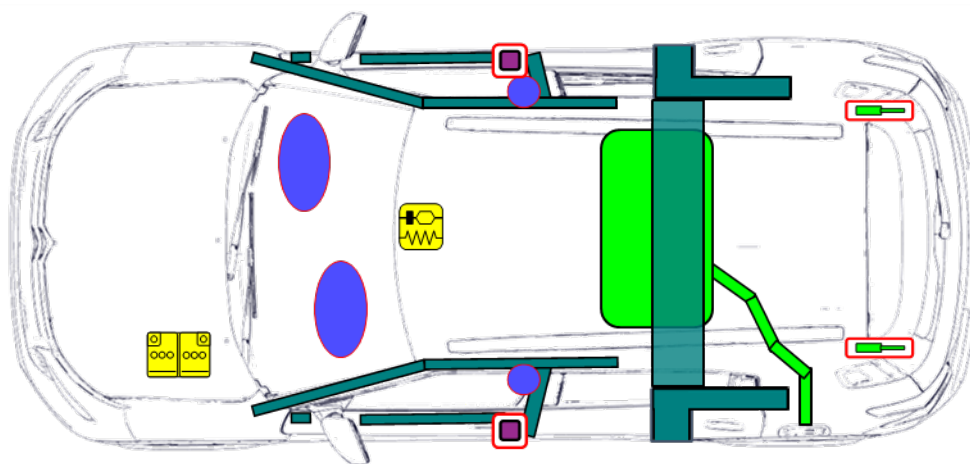

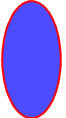
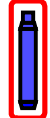





FICHA DE RESGATE

PORTUGUÊS

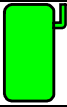
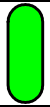

	Airbag		Gerador de gás		Pré-tensionador do cinto de segurança		Modulo eletrônico de controle		Sistema de proteção de pedestre
	Sistema de proteção automática contra capotamento		Amortecedor a gás / mola pré-carregada		Reforço estrutural		Zona que requer atenção especial		
	Bateria 12V		Ultra capacitor / baixa tensão		Tanque de Combustível		Tanque de Gás		Válvula de Segurança
	Bateria de alta voltagem		Cabo de alimentação / componente de alta tensão		Desconexão de alta tensão		Caixa de fusível desativando o sistema de alta tensão		Ultra capacitor / alta tensão











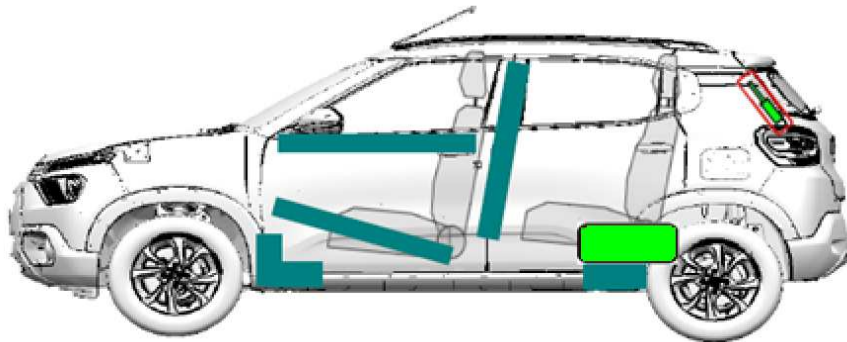
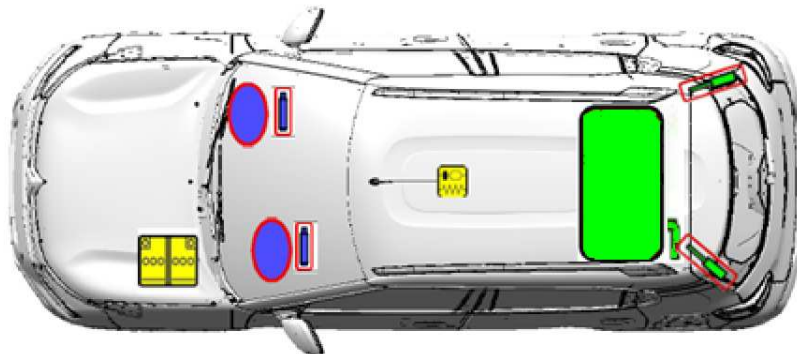

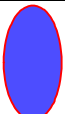
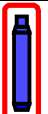





	Airbag		Gerador de gás		Pré-tensionador do cinto de segurança		Modulo eletrônico de controle		Sistema de proteção de pedestre
	Sistema de proteção automática contra capotamento		Amortecedor a gás / mola pré-carregada		Reforço estrutural		Zona que requer atenção especial		
	Bateria 12V		Ultra capacitor / baixa tensão		Tanque de Combustível		Tanque de Gás		Válvula de Segurança
	Bateria de alta voltagem		Cabo de alimentação/ componente de alta tensão		Desconexão de alta tensão		Caixa de fusível desativando o sistema de alta tensão		Ultra capacitor / alta tensão



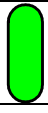







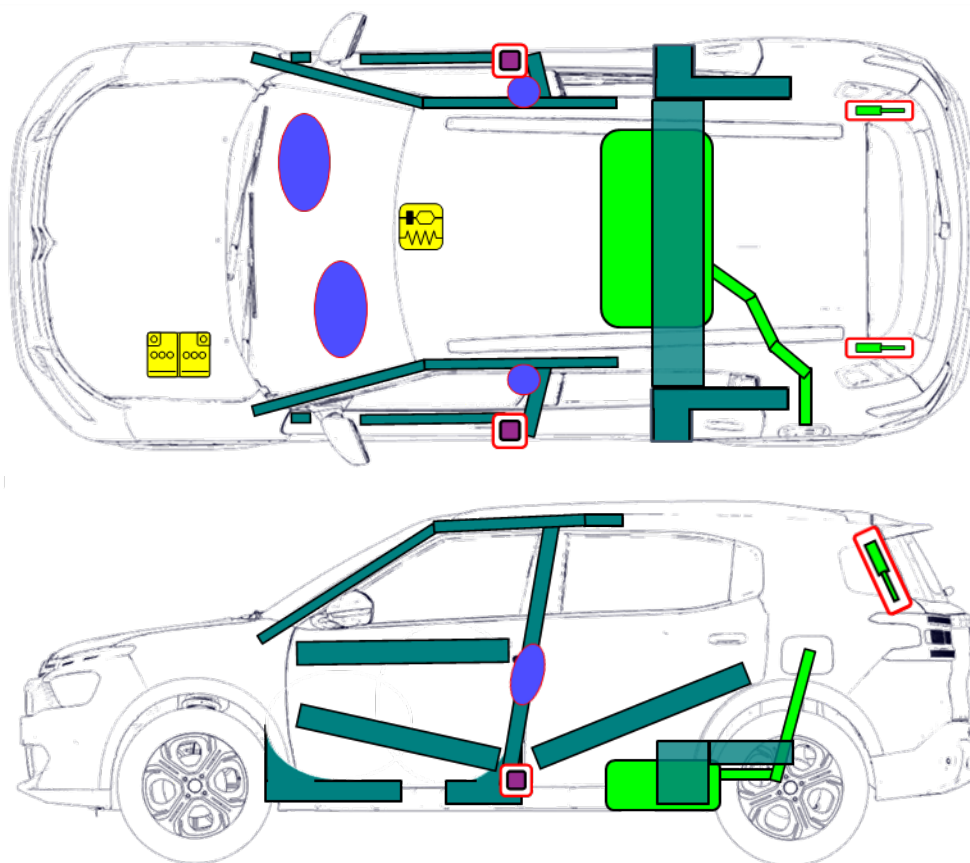

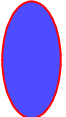







FORMULARIO DE REDENCIÓN

ESPAÑOL



	Airbag		Generador de gas		Pretensor del cinturón de seguridad		Módulo de control electrónico		Sistema activo de protección de peatones
	Sistema automático de protección contra vuelcos		Amortiguador de gas / resorte precargado		Zona de alta resistencia		Zona que requiere atención especial		
	Batería 12V		Ultra condensador, bajo voltaje		Depósito de combustible		Tanque de gas		Válvula de seguridad
	Paquete de baterías de alto voltaje		Cable de alimentación / componente de alto voltaje		Desconexión de alto voltaje		Caja de fusibles que desactiva el sistema de alto voltaje		Ultra condensador, alto voltaje











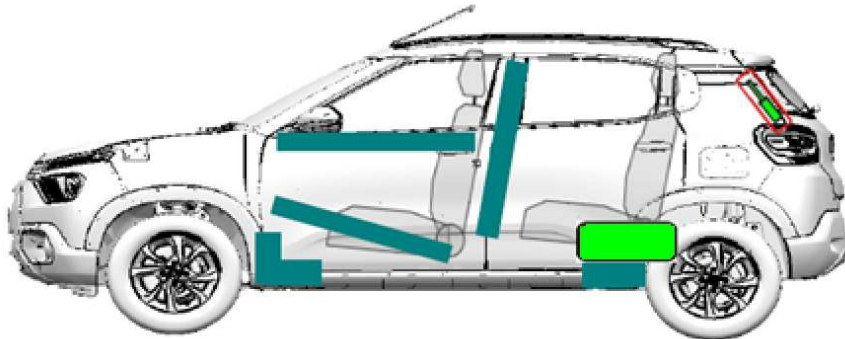
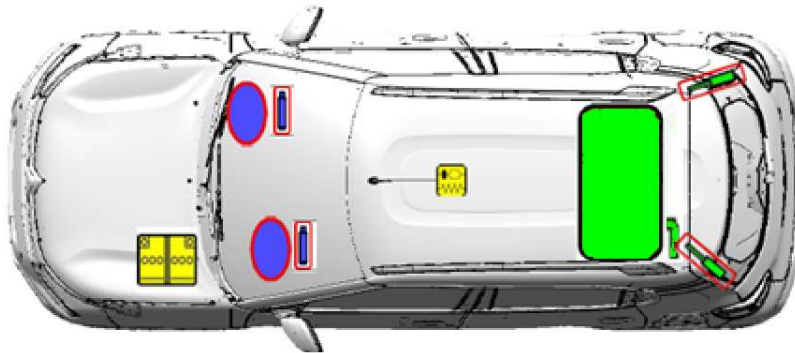

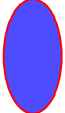







	Airbag		Generador de gas		Pretensor del cinturón de seguridad		Módulo de control electrónico		Sistema activo de protección de peatones
	Sistema automático de protección contra vuelcos		Amortiguador de gas / resorte precargado		Zona de alta resistencia		Zona que requiere atención especial		
	Batería 12V		Ultra condensador, bajo voltaje		Depósito de combustible		Tanque de gas		Válvula de seguridad
	Paquete de baterías de alto voltaje		Cable de alimentación / componente de alto voltaje		Desconexión de alto voltaje		Caja de fusibles que desactiva el sistema de alto voltaje		Ultra condensador, alto voltaje











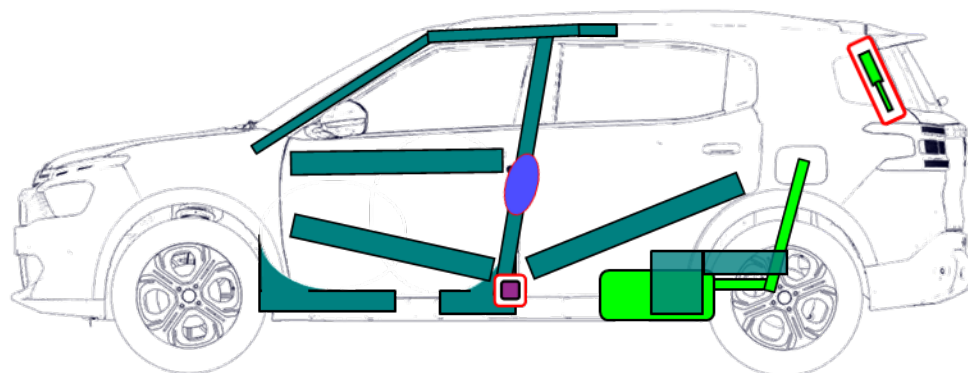
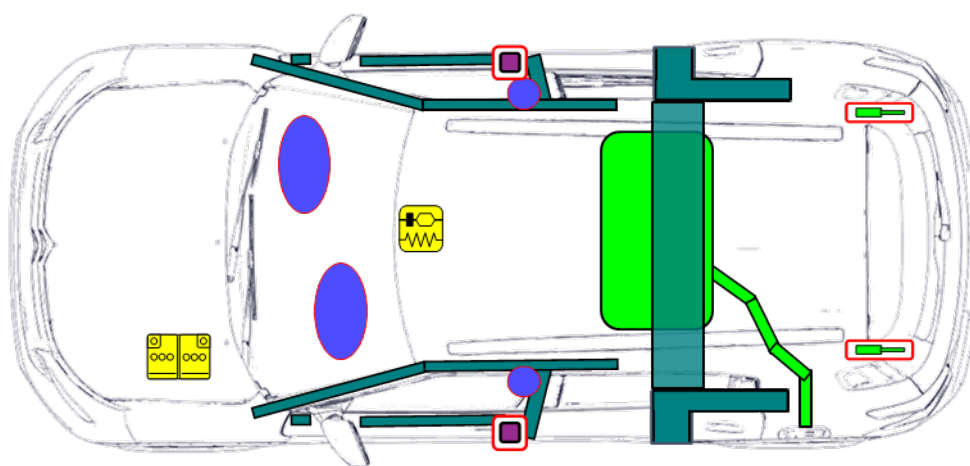

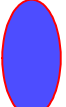



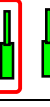

RESCUE SHEET

ENGLISH

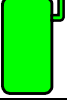
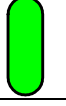

	Airbag		Stored gas inflator		Seat belt pretensioner		SRS control unit		Pedestrian protection active system
	Automatic rollover protection system		Gas strut / Preloaded spring		High strength zone		Zone requiring special attention		
	Battery low voltage		Ultra capacitor, low voltage		Fuel tank		Gas tank		Safety valve
	High voltage battery pack		High voltage power cable / component		High voltage disconnect		Fuse box disabling high voltage system		Ultra capacitor, high voltage



	Airbag		Stored gas inflator		Seat belt pretensioner		SRS control unit		Pedestrian protection active system
	Automatic rollover protection system		Gas strut / Preloaded spring		High strength zone		Zone requiring special attention		
	Battery low voltage		Ultra capacitor, low voltage		Fuel tank		Gas tank		Safety valve
	High voltage battery pack		High voltage power cable / component		High voltage disconnect		Fuse box disabling high voltage system		Ultra capacitor, high voltage